

# HP Series Smart Solar Charge Controller

(HP2430/2440/2450/2460 HP4830/4840)

## User Manual



goinggreen@paragonenergy.ca

www.paragonenergy.ca

### Product Features

- Automatic system voltage identification.
- Charging program options for sealed, GEL and flooded lead-acid batteries and lithium batteries are available.
- An upgraded 3-stage PWM charging algorithm is adopted. Application of an equalizing charge to the battery periodically or when over discharged, can effectively prevent the battery from non-equalization and sulfuration, thus extending the battery's service life (with the exception of GEL and lithium batteries).
- With temperature compensation employed, charging parameters can be automatically adjusted (with the exception of lithium batteries).
- A wide range of load working modes facilitate the product's application to different types of street lights and monitoring devices.
- The product provides overcharge, over-discharge, overload protection, as well as short-circuit and reverse-connection protection.
- By virtue of an advanced load starting method, large-capacitance loads can be started smoothly.
- A range of parameter settings and power-down saving functions are available, thus requiring no repeated setting.
- The product provides a dot matrix graphic LCD screen and a human-machine interface with 2 keys.
- The user-friendly design of browser and dynamic interfaces ensures convenient and intuitive operations.
- (An optional communication function) provides a RJ12 data port (output of TTL232 level or bluetooth signals), with the data adopting the standard Modbus protocol, can be used together with our upper computer monitoring software or mobile phone APP.
- Boasting an industrial grade design, the product can function well in various tough conditions.
- TVS lighting protection is adopted.

### Panel Structure

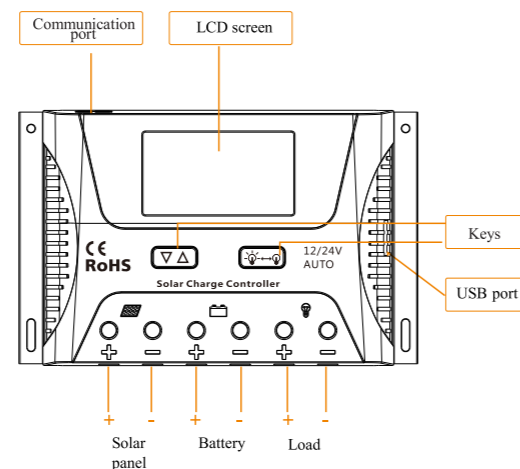

### State Indicators

LCD Icon	Indicated Object	State	Meaning
☀	Day recognition	Steady on	Day time
☾	Night recognition	Steady on	Night time
☀	Solar panel	Steady on	Solar panel indication
BOOST	Charging state	Steady on	Boost charging
FLOAT		Steady on	Floating charging
EQUATIZE		Steady on	Equalizing charging
🔋	Battery	Quick flashing	Battery overvoltage
		Slow flashing	Battery over-discharge
🔋	Battery SOC	4 dashes	100%
		3 dashes	75%
		2 dashes	50%
		1 dash	25%
		0 dash	0%
💡	Load	Steady on	Load turned on
		Steady on	Load turned off
		Quick flashing	Overload or short-circuit protection

### Five load Working Modes

- Pure light control (0):** When sunlight disappears and the light intensity drops to the starting point (light control off), the controller initiates a 10-minute delay (settable) to confirm the starting signal, and then switches on the load for operation. When sunlight emerges and the light intensity reaches the starting point, the controller initiates a 1-minute (fixed) delay to confirm the shutting-down signal, and then shuts down the output to stop the load's operation.
- Light control + time control (1 to 14):** The starting process is the same as pure light control. After operating for a preset period of time (settable from 1 to 14 hours), the load stops operation automatically.
- Manual mode (15):** In this mode, the user can switch the load on or off by the keys, no matter whether it's day or night.
- Debugging mode (16):** When the solar panel voltage is higher than the "light control off" voltage, switch off the load immediately; when the solar panel voltage is lower than the "light control on" voltage, switch on the load immediately.
- Normal on (17):** The energized load keeps in output state.

LCD Display	Mode	LCD Display	Mode
0	Pure light control mode	9	Light control + time control (9 hours)
1	Light control + time control (1 hour)	10	Light control + time control (10 hours)
2	Light control + time control (2 hours)	11	Light control + time control (11 hours)
3	Light control + time control (3 hours)	12	Light control + time control (12 hours)
4	Light control + time control (4 hours)	13	Light control + time control (13 hours)
5	Light control + time control (5 hours)	14	Light control + time control (14 hours)
6	Light control + time control (6 hours)	15	Manual mode
7	Light control + time control (7 hours)	16	Debugging mode (default)
8	Light control + time control (8 hours)	17	Normal on mode

### Load Working Mode Settings

In the load mode menu, long press  $\nabla \Delta$  for 2s, and the number (e.g. 15) will begin to flash. Press  $\nabla \Delta$  to adjust the mode (from 0 to 17), and then long press  $\nabla \Delta$  again for 2s to complete and save the setting.  
 Note: 1. After parameter adjustment, if  $\nabla \Delta$  is not pressed and held long enough for exiting, the system exits to the main menu after 12s, and the parameter that was set is not saved.  
 2. When the system is saving data, the screen may shake slightly. This is normal and the user may ignore it.

### Safety Advice

- When connected to a 24 V or 48V system, the solar panel terminal voltage may exceed the limit for human safety. If operation is to be performed, be sure to use insulation tools and keep your hands dry.
- If the battery is reversely connected, the controller itself won't be damaged, but the load end will have a negative voltage output, which may damage your load device. Take care not to let this happen.
- In the 48V system, separate reverse connect battery or separate reverse connection of solar panel controller will not damage; but if in reverse connection of the battery and is connected solar panels, or solar panels on the reverse connection is connected to the battery may cause damage to the controller.
- The battery contains a large amount of energy. Therefore, in no cases should the battery be short circuited. It's recommended that a fuse be serially connected to the battery.
- Keep the battery away from fire sparks, as the battery may produce flammable gas.
- Keep children away from the battery and controller.
- Follow the safety advice provided by the battery manufacturer.

### LCD Screen Illustration

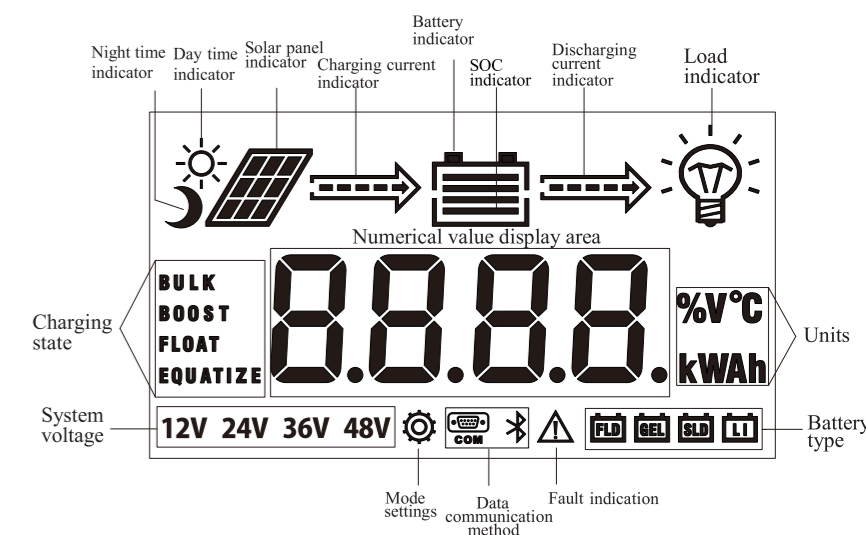

### Browsing Menu on LCD Screen

1) Continuously press  $\nabla \Delta$ , the screen will display the following in order: "main menu"---"solar panel voltage"---" solar panel current"---"battery capacity"---"battery voltage"---"discharging current"---"charging amp-hrs"---" dischargingamp-hrs"---" temperature inside controller"---" load mode"---" load modesettings"---"error code", and then back to "main menu". If the keys are not operated for 12s, the system will automatically return to display the "main menu"

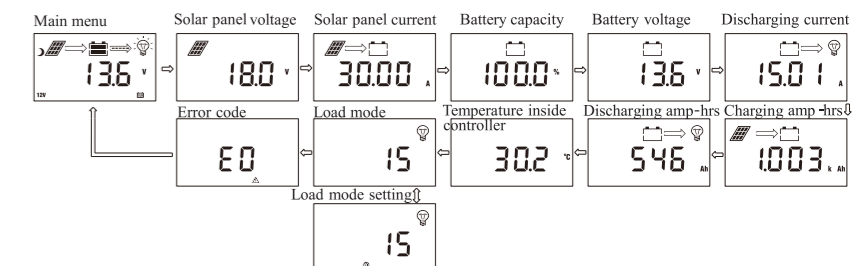

## Setting Menu on LCD Screen

2). When "load mode" is displayed, long press to enter into the load mode setting. Press to adjust the mode, and long press for 2s to save and exit; or else, the system will not save the setting that was just made and automatically exits the setting after 12s.

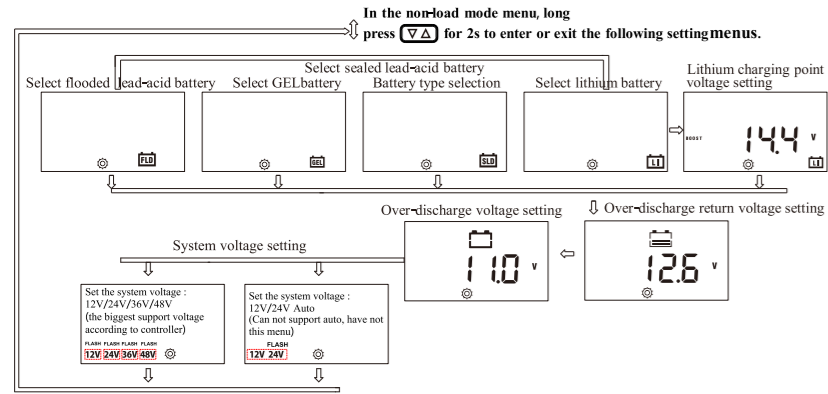

## Battery Types, Charging Voltages (Lithium Battery), Over-Discharge Return and Over-Discharge Voltage Settings

In the non-load mode menu:  
 1) When is long pressed, the first interface entered is for battery type setting, and the flashing one is the battery type currently selected. Press to select among FLD/GEL/SLD/LI.  
 2) After selection, short press to enter into over-discharge return and over-discharge voltage settings; or the first to enter charging voltage setting menu for lithium battery.  
 3) After parameters have been set, long press for 2 s to save and exit.

Parameters shall be set according to the following rule: over-discharge voltage < over-discharge return voltage ≤ under-voltage warning < floating charging voltage < boost charging return ≤ equalizing charging voltage < overcharge voltage; and two adjacent values shall have a difference greater than 0.5 V.

## Charging and Discharging Overload Protection and Recovery Time

In the charging and discharging overload protection mechanism, the relation between overload current and protection time is as follows: An overload current 1.25 times of the rated current initiates a delay of 30s before starting protection; similarly, 1.5 times, 5s and 2 times, 1s. Overload recovery: automatic recovery after 1 minute.

## Load Short Circuit and Recovery

Short-circuit automatic recovery time: 1st time, 5 s; 2nd time, 10 s; 3rd time, 15 s; 4th time, 20 s; 5th time, 4 hours or automatic recovery the next day; or long press to make the load resume output.

## Communication Port Line Sequence (Only for Controllers with Communication Functions)

### Controller communication port RJ12 (6 - pin)

RS232

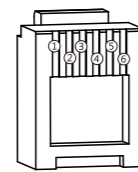

No.	Definition
①	Transmitting terminal TX
②	Receiving terminal RX
③	Power supply grounding /Signal grounding
④	Power supply grounding /Signal grounding
⑤	Power supply positive
⑥	Power supply positive

## Mobile Bluetooth APP Wireless Monitoring (Optional)

**1. Mobile Wireless Monitoring Features:**  
 1) The controller supports a built-in Bluetooth module or external adapter, which is plug and play and easy to set up.  
 2) Bluetooth module applies a Bluetooth 4.0 low energy technology, providing a rapid communication and strong anti-interference capability.  
 3) Communication distance is up to 15 meters.  
 4) Rich data display and setting functions meet the wireless monitoring requirements for solar controller data: Real-time monitoring of (solar panel voltage, solar panel current, charging power, panel state, battery level, battery voltage, charging current, battery status, charging status, load switch, load current, load power and other information)

Historical data (including: power generation, power consumption, charging ampere hours, discharging ampere hours, maximum charging power, maximum discharging power, minimum battery voltage and maximum battery voltage of the day, as well as running days, number of battery over-discharge, number of battery full charge, total battery charging ampere hours, total battery discharging ampere hours, accumulated power generation and accumulated power consumption)

Historical data (including: provide a monthly and yearly historical data summary chart for various parameters.)  
 Parameter settings (including system voltage, battery capacity, battery type, overvoltage, limited charge voltage, equalizing charge voltage, boost charge voltage, floating charge voltage, boost charge return voltage, over-discharge return voltage, under-voltage warning voltage, over-discharge voltage, limited discharge voltage, over-discharge delay time, equalizing charge time, boost charge time, equalizing charge interval, and temperature compensation information)

Device information (Controller ID, Device Version, Device SN, Device Status)  
**2. Following conditions shall be met to achieve mobile wireless monitoring:**  
 1) The controller shall provide a built-in low energy Bluetooth module BLE4.0, or come with an external "BT-1" Bluetooth adapter to its communication interface;  
 2). A mobile phone on Android 4.3 or above version or an iPhone shall be prepared, and corresponding app shall be downloaded and installed.  
**3. Approach of Getting the Mobile APP: (App administrator password is: 135790123)**

1) Android App Download: Search for SolarLink App in the "Google Play store" and download.  
 2). IOS App Download: Search for Solar App in the "SRNE" and download.

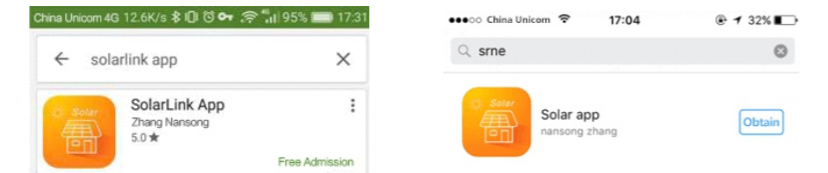

## Installation Instructions and Precautions

**1) The controller shall be installed securely, and its dimensions are as follows:**  
 HP2430/2440 External dimensions: 164.0×103.5×47.0 (mm)  
 Installation dimensions: 154×85 (mm)

HP2450/2460 External dimensions: 189.27×127.2×54.0 (mm)  
 Installation dimensions: 180×92.2 (mm)

HP4830/4840 External dimensions: 189.27×127.2×54.0 (mm)  
 Installation dimensions: 180×92.2 (mm)

**2) Installation hole diameter: 3.2 (mm)**

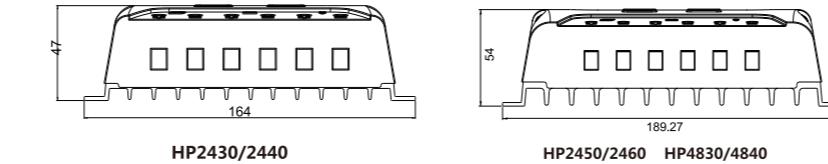
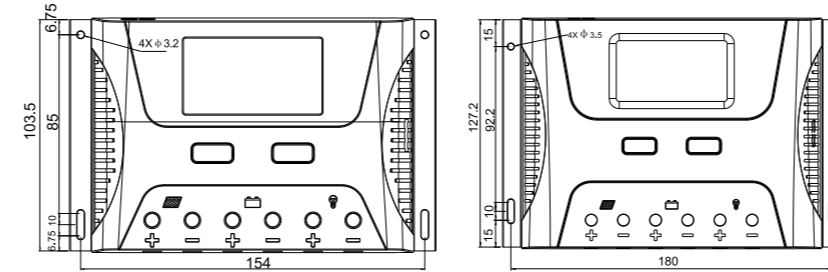

**3. Precautions:**

- If it is 12V system, the bottom left corner of LCD display will show '12V', 24V system will show '24V', 36V system will show '36V', 48V system will show '48V'.
- The first step is to connect the battery. If the connection is made correctly, the controller screen will light up; otherwise, check whether the connection is correct.
- The second step is to connect the solar panel. If sunlight is present and strong enough (the solar panel voltage is greater than battery voltage), the sun icon on the LCD screen is on; otherwise, check whether the connection is correct (it's recommended that the operation be performed under the debugging mode).
- The third step is to connect the load. Connect the load leads to the controller's load output terminal, and the current shall not exceed the controller's rated current.
- As the controller will generate heat during operation, it's recommended that the controller be installed in an environment with good ventilation conditions.
- Choose cables with large enough capacity for connection, in case too much loss incurred on the lines causes the controller to misjudge.
- The controller has a common positive pole inside. If grounding is needed, ground the positive pole.
- It's important to fully charge the battery regularly. At least once full charging every month is recommended, and failure to do that may cause permanent damage to the battery. Only when in-flow energy outpaces that out-flow energy can the battery be charged fully. Users shall bear this in mind when configuring the system.
- Check whether the controller's each connection terminal is tightened securely; if not, it may suffer damage when large current passes.

## Error Code List

Code on LCD screen	Corresponding error
E0	No error
E1	Battery over discharge
E2	Battery overvoltage
E3	Undervoltage warning
E4	Load short circuit
E5	Load overload
E6	Temperature too high inside controller
E8	Charging current too high
E10	Solar panel input voltage is too high

## Common Problems and Solutions

Symptoms	Causes and Solutions
LCD screen does not light up	Check whether the battery is correctly connected.
Incomplete display or no renewal on LCD screen	Check whether the ambient temperature is too low and whether the display recovers when the temperature rises.
No charging with sunlight present	Check whether the solar panel is correctly connected and contact is good and reliable. Check whether the solar panel voltage falls below the battery voltage.
The sun icon does not light up, while the solar panel icon does. The battery voltage is normal, but there is no output.	The load will be switched on automatically after 10 minutes (set by the user).
The battery icon flashes quickly, and there is no output.	System overvoltage. Check whether the battery voltage is too high.
The battery icon flashes slowly, and there is no output.	The battery is over-discharged, and will recover when recharged adequately.
The load icon flashes quickly, and there is no output.	The load's power exceeds the rated value or it's short-circuited. After removing the problem, long press the key or wait until it recovers automatically.
The load and the encircling light ring stays lit, and there is no output.	Check whether the power-consuming device is connected correctly and reliably.
Other symptoms	Check whether wiring is sound and reliable, and system voltage is correctly recognized.
The charging and discharging amp-hrs displays: 9999.K Ah	The decimal point flashes indicating that the displayed value has reached its upper limit. Long press  to reset it.

## Parameter Details

Model	HP2430/2440	HP2450/2460	HP4830/4840	Remarks	
Rated current	30A/40A	50A/60A	30A/40A		
System voltage	Automatic recognition of 12V/24V		Automatic recognition of 12V/24V/36V/48V	Default automatic identification	
Rated power	12V/450W 24V/900W	12V/600W 24V/1200W	12V/750W 24V/1500W	12V/450W 24V/900W 36V/1350W 48V/1800W	12V/600W 24V/1200W 36V/1800W 48V/2400W
	Manual setup				
No-load loss	< 13mA/12V ; < 15mA/24V		<30mA	The lower the system voltage, the smaller the no-load loss.	
Max. Solar energy input voltage	<55V		<110V		
Max. voltage at the battery end	<34V		<68V		
Battery type	Parameters				
	Flooded FLD	Sealed SLD	GEL GEL	Lithium LI	Default SLD
Overvoltage protection	16.0V				
Equalizing charging voltage	14.8V	14.6V	-	-	×1/12V ;
Boost charging voltage	14.6V	14.4V	14.2V	14.4V	×2/24V ;
Floating charging voltage	13.8V	13.8V	13.8V	-	×3/36V ;
Charging recovery voltage	13.2V				×4/48V ;
Over-discharge recovery voltage	12.5V ( settable with the keys )				
Over-discharge voltage	11.0V ( settable with the keys )				
Equalizing charging interval	30days	-	-	-	
Equalizing charging time	1H	-	-	-	
Boost charging time	2H				
Temperature compensation	-3.0mV/°C/2V				
Light control voltage	Light control on 5V, light control off 6 V (light control on plus 1 V)				×1/12V ; ×2/24V ; ×3/36V ; ×4/48V ;
Light control judgment time	10minutes				
USB function	Yes	optional	No		
Bluetooth fuction	optional				
Operating temperature	-25°Cto+55°C ;				
IP protection degree	IP30				
Net weight	390g	650g	650g		
Protection functions	Battery plate reverse connection protection <sup>Ⓟ</sup> , a battery reverse connection protection <sup>Ⓟ</sup> , charging battery board short circuit protection, charging the battery open circuit protection, charging over current protection, overload protection, load short-circuit protection controller and over temperature protection.				
Dimensions	164.0×103.5×47.0(mm)	189.27×127.2×54.0 (mm)	189.27×127.2×54.0 (mm)		

Note:①&② : HP4830/40 reverse connect panels, please do not connect battery at the same time; When the battery reverse connect, please do not connect panels at the same time. Otherwise it may cause damage of controller.